

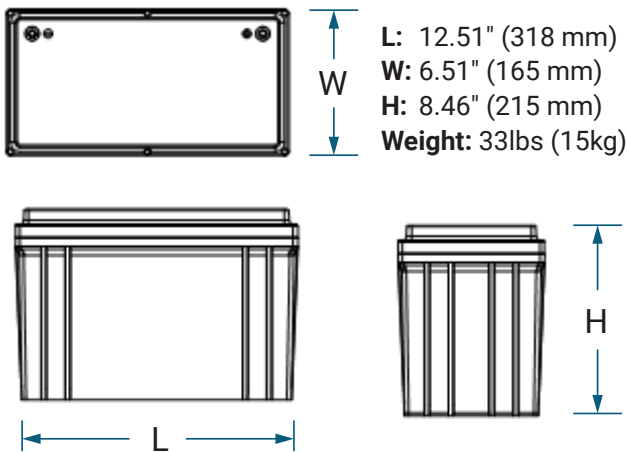

PSL-BTP-121250 12.8V 125.0 AH

Rechargeable Lithium Iron Phosphate Battery
PSL-BTC – LiFePO4 Series Connection Range

DIMENSIONS: inch (mm)



Dimensional Tolerances +/- 0.08 in. (+/- 2mm) for length, width and height

TERMINAL

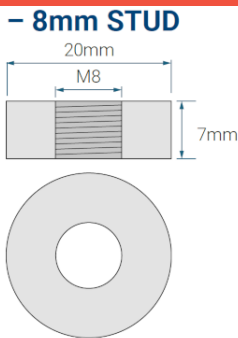

BATTERY FEATURES

- Super safe lithium iron phosphosphate (LiFePO4) chemistry reducing the risk of explosion or combustion due to high impact, over-charging or short circuit situation
- Bluetooth® communication capability for battery status through Power Sonic app
- Battery Management System (BMS) controls the parameters of the battery to provide optimum safety by protecting against over-charging and over-discharging
- BMS enhanced design balances the battery cells, optimizing battery performance
- Delivers twice the power of lead acid batteries, even at high discharge rates, while maintaining high energy capacity
- Faster charging and lower self-discharge
- Up to 10 times more cycles than lead acid batteries
- Compact and only 40% of the weight of comparable lead acid batteries
- Rugged impact resistant ABS case and cover flame retardant to UL94:V0

APPROVALS

- UL 1642 cell certificate
- UN 38.3 Certified
- ISO9001:2015 – Quality management systems



INTELLIGENT BATTERY MANAGEMENT SYSTEM

The PSL-BTC Series come with an intelligent battery management system which monitors current and voltages during charge and discharge. This protects the battery from over-charge and over-discharge.

The BMS embeds smart balancing algorithms that control all cell voltages in the battery, making sure they are constantly at the same voltage level, optimizing battery capacity.

BLUETOOTH® ENABLED

Monitor the State of Charge (SoC), State of Health (SoH), current, capacity, temperature, number of cycles, and voltage levels of the battery and individual cells from our Power Sonic app.

APPLICATIONS

- Medical
- Solar
- Wind
- Mobility
- Data Center
- Transport
- Sports & Recreation
- Utility

CORPORATE HEADQUARTERS (USA AND INTERNATIONAL EXCLUDING EMEA)

Power-Sonic Corporation
365 Cabela Dr Suite 300,
Reno, Nevada 89523 USA
T: +1 619 661 2020
E: customer-service@power-sonic.com

POWER-SONIC EMEA (EMEA – EUROPE, MIDDLE EAST AND AFRICA)

Smitspol 4, 3861 RS Nijkerk,
The Netherlands
T NL: + 31 33 7410 700
T UK: + 44 1268 560 686
T FR: + 33 344 32 18 17
E: salesEMEA@power-sonic.com

SELECTING A BATTERY FOR APPLICATION

Selection of LiFePO4 Based on Current

Choosing the appropriate LiFePO4 battery for any application, whether the application is based on current draw or power draw, is easier with a LiFePO4 battery than with a sealed lead acid (SLA) battery. The capacity of a lithium battery, as illustrated by Figure 1, is substantially independent of the discharge current. Thus, the selection of the lithium battery is simply the discharge current requirement multiplied by the time over which the discharge current is required. For instance, if a 10A draw is required for 2 hours or a 5A draw is required for 4 hours, a 20Ah lithium battery is appropriate for the application.

The second aspect of a lithium battery that makes it easier to size for an application is that the cutoff voltage (as displayed in Figure 2) is 10V, independent of discharge rate. Whereas with an SLA battery, the voltage changes with discharge rate. The cut-off voltage of a lithium battery is also controlled via the protection circuit. It is good practice to set the cut-off voltage to be slightly higher than the recommended cut-off voltage. This will keep the battery from shutting down due to protection.

Selection of LiFePO4 Based on Power Draw

Choosing the appropriate lithium battery based on power draw is also easier than with an SLA battery. The voltage drop during discharge for a lithium battery is essentially constant, as shown in Figure 2. The constant voltage drop leads to a constant power through discharge, as power is voltage times current draw. As with capacity, power draw is a simple calculation for the selection of the battery. For instance, a voltage of a lithium battery can be assumed to be a constant 12.8 V during discharge, hence if 256 Whr are required for the application to be delivered for a 2 to 4 hour discharge a 10 Ah battery can be used (e.g. $12.8\text{ V} \times 5\text{ Ah} \times 4\text{ Hr} = 256\text{ Whr}$ and $12.8\text{ V} \times 10\text{ Ah} \times 4\text{ Hr} = 256\text{ Whr}$) to deliver constant power.

ENVIRONMENTAL FACTORS

Impact of Ambient Temperature on Capacity

The impact of ambient temperature on capacity is shown in Figure 3. In general, increasing temperature increases the capacity of a LiFePO4 battery. The effect is shown in the Discharge Specifications table. Discharging the battery below -10°C is not recommended. Depending on application, the self-heating of the battery may counteract the effects of the low temperature and extended the ambient temperature range over which the battery will discharge.

Cycle Life (Including the Effects of Ambient Temperature)

Cycle life in Figure 4 is to 100% Depth of Discharge (DoD) at 25°C , 45°C and 55°C . The cycle life at other DoD can be approximated by the ratio of the DoD to 100%, for example a 50% DoD at 25°C would result in 2000 cycles based on Figure 4. For temperatures other than those shown on the graph, an interpolation can be done at that temperature. For temperatures below 25°C , the cycle life at 25°C can be used.

When compared to an SLA battery at 25°C , a LiFePO4 battery's cycle life is ten times longer. Even at elevated temperatures, the LiFePO4's cycle life is still longer than an SLA's when at room temperature, as demonstrated in Figure 4. Therefore, in replacing an SLA with LiFePO4, the LiFePO4 will always have a longer cycle life.

CHARGING

Charging a LiFePO4 battery

The lithium battery follows a similar charge profile as an SLA battery. It starts with constant current (CC) followed by constant voltage (CV). The standard LiFePO4 profile is 0.2C CC charge to 14.6V, the a CV at 14.6V charge until the charge current declines to $\leq 0.05\text{C}$. A fast charge current of 1C may be used as necessary. Note that continual fast charging may shorten the battery life and therefore capacity. Any charger with a lithium setting is suitable.

However, when using an SLA charger the protocols used for charge initialization and maintenance must be considered.

The biggest difference between LiFePO4 and SLA is the way the battery responds upon initial charging when over-discharged and the preferred maintenance when fully charged. Using an SLA charger with a de-sulfation setting will damage the battery, and chargers with an OCV detection setting may fail to wake up an over-discharged battery. After the end-of-charge, it is not necessary to keep the LiFePO4 battery on a float charge, but may be maintained with a topping charge if the voltage drops. If a charger has a float setting, it will not damage the LiFePO4 battery.

CAPACITY OF LiFePO4 vs. LEAD ACID AT VARIOUS CURRENTS OF DISCHARGE

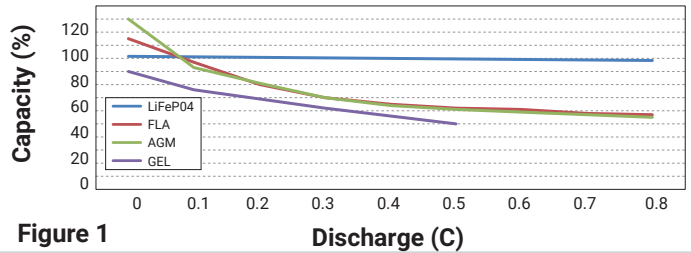

Figure 1

DISCHARGE VOLTAGE PROFILES AT VARIOUS RATES 25°C AMBIENT TEMPERATURE

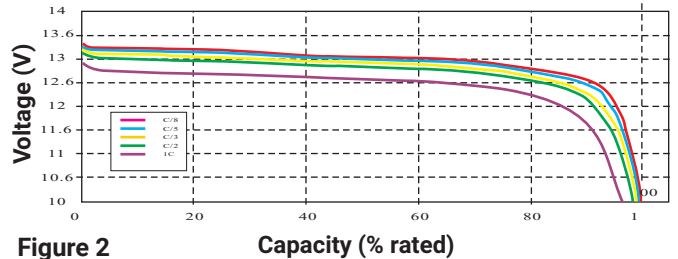

Figure 2

DISCHARGE VOLTAGE PROFILES AT 0.5C DISCHARGE RATE VARIOUS AMBIENT TEMPERATURES

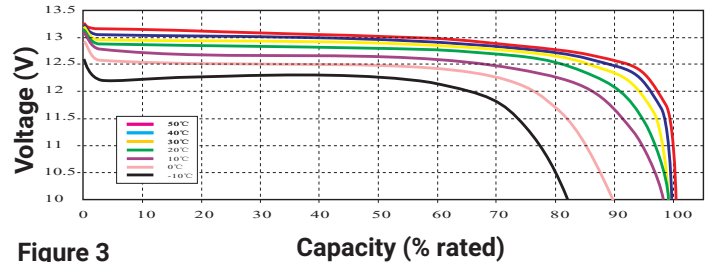

Figure 3

CYCLE LIFE vs. VARIOUS TEMPERATURE 0.2C CHARGE/0.5C DISCHARGE @ 100% DOD

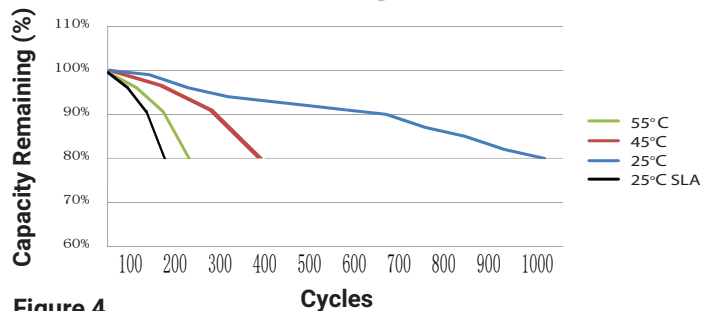

Figure 4

CHARGING CHARACTERISTICS (0.2C AMP @ 25°C)

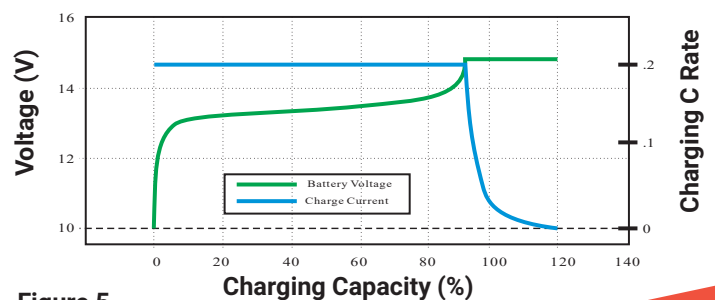

Figure 5

BATTERY MANAGEMENT SYSTEM

Electrical Characteristics

The battery management system (BMS) is a programmable circuit board used to protect the battery during charging and discharging. The protection is provided by monitoring voltages, current, lithium cell temperature and circuit board temperature and comparing the monitored values to predetermined limits used to protect the battery from damage. If one of the variables being monitored exceeds a limit, the BMS will disable either the charging or discharging circuit, depending on the state of the battery, to prevent current flowing into or out of the battery to protect the battery from damage. The battery will exit the protection mode based on the release method described BMS protections.

GENERAL PERFORMANCE SPECIFICATIONS		BMS SPECIFICATIONS									
Nominal Voltage	12.8V	Voltage	Charging 14.6V								
Rated Capacity	125AH at a Constant Current of 0.33C to 9.2V		Balancing 13.8V								
Life Expectancy (Years)	5 years (1 cycle/day)	Current	Self-discharge ≤3%/month								
Cycle Life (100% DoD)	2000 cycles		Max Charging 80A								
Assembly Method	4S5P		Max Discharging 100A								
Housing Material	ABS	Over-charging Protection	Over-charging Voltage 3.90±0.03V/Cell								
Series Connection	Cannot be connected in series		Over-charge Delay Time 1-2s								
Parallel Connection	4 in parallel		Over-charging Release Voltage 3.60±0.05V/Cell								
Internal Monitoring	BMS	Over-discharging Protection	Over-discharging Voltage 2.00±0.05V/Cell								
Communication	Bluetooth		Over-discharge Delay Time 1-2s								
			Over-discharging Release Voltage 2.50±0.05V/Cell								
		Over-current Protection	Over-current (Discharge) 400-500A								
			Over-current Delay Time 50s-200ms								
			Release Condition Charge to release								
		Short Circuit Protection	Do not short circuit the electrodes.								
		Impedance	≤15.0mΩ								
		Over-temperature Protection	Charge Over-temperature Protection 65±5°C								
			Charge Release Temperature 50±5°C								
			Discharge Over-temperature Protection 65±5°C								
			Discharge Release Temperature 50±5°C								
		Low Temperature Protection	Charge Low Temperature Protection -10±5°C								
			Charge Release Temperature 0±5°C								
CHARGE SPECIFICATIONS											
Charge Temperature Range	0-45°C										
Charge Voltage	14.6V										
Recommended Float Charge Voltage (For Standby Use)	13.8V										
Max Charge Current	80A at 20°C										
Recommended Charge Current	0.33C										
Charge Cut-off Voltage	15.6V										
Standard Charge	0.33C constant current charge to 14.6V then constant voltage 14.6V charge until charge current declines to ≤0.05C										
DISCHARGE SPECIFICATIONS											
Discharge Temperature Range	-20-60°C										
Recommended Output Voltage Range	12.8-10V										
Max Continuous Discharge Current	100A at 20°C										
Discharge Cut-off Voltage	10V										
Standard Discharge	Constant Current 0.5C										
Discharge Temperature Characteristics	<table border="1"> <tr> <td>-20°</td> <td>70%</td> </tr> <tr> <td>0°</td> <td>80%</td> </tr> <tr> <td>25°</td> <td>100%</td> </tr> <tr> <td>55°</td> <td>95%</td> </tr> </table>	-20°	70%	0°	80%	25°	100%	55°	95%		
-20°	70%										
0°	80%										
25°	100%										
55°	95%										
STORAGE SPECIFICATIONS											
Self-discharge Rate	<3% / Month										
Storage Temperature Range	<3 Months	-5-35°C									
	<1 Year	0-25°C									
Recommended Storage SOC	Recommended storage range is 50% State of Charge. We recommend cycling the battery once every three months if it is in long-term storage.										

TESTING CONDITIONS

Electrical Characteristics

Ambient Temperature: 25±2°C

Humidity: 45-75%

Testing Parameters

Tests should be conducted with batteries that have less than 5 cycles before the test.

STANDARD CHARGE AND DISCHARGE

Standard Charge

Charge at 0.33C constant current until the battery reaches 14.8V. The battery then charges at constant voltage of 14.6V while tapering the charge current. Charging will end when the current has tapered to 0.05C. The battery should be charged between 0 °C and 45 °C, then rest for 30 minutes before discharging. Do not exceed the max charging current, voltage, or temperature limits as specified in this document. Do not reverse-polarity charge the battery.

Standard Discharge

Battery should be discharged at a constant current of 0.33C to 9.2V at 20±5 °C, then rest for 60 minutes before charging.

Storage

The batteries should be stored open circuit, and protected against the possibility of a short between the terminals. The battery should be charged once every 6 months if not in use to prevent over-discharging. They batteries should be stored at room temperature, and charged to 30-50% SOC.

Warnings

If the battery is over-charged and over-discharged too frequently, this will affect the long-term performance and capacity of the battery. If the battery is stored for too long, reduced capacity and performance can be expected. It is important to cycle the battery at least once every 6 months and stored at the appropriate SOC to prevent deterioration to the battery.

WARNINGS AND TIPS

Short Circuit

Do not short circuit battery. If the battery is short-circuited, it causes excessive heat which will damage the battery and possibly it's surroundings.

Warnings

Do not drop, throw, or crush battery.
Do not throw the battery into water or fire.
Keep battery away from heat sources, high voltage, and other high-temperature sources.
Do not leave the battery exposed to sunlight for extended periods of time.
Do not attempt to disassemble the battery.
Batteries in strings must always be matched by chemistry, capacity, voltage, and SOC.
Do not connect in reverse polarity.

Tips

Keep the battery away from high-temperature environments. This can cause over-heating, fire, reduction in battery life, and/or loss of other battery functions.
Use matched or suggested charger for this battery.
When battery runs out of power, charge your battery in a timely manner (15 days or less). This will prevent premature aging of the battery.
Stop using the battery immediately if it emits a burning smell, too much heat, or appears distorted.

FURTHER INFORMATION

Please refer to our website www.power-sonic.com or email us at technical-support@power-sonic.com for a complete range of useful downloads, such as product catalogs, material safety data sheets (MSDS), ISO certification, etc.

PSL-BT BATTERIES PARALLEL CONNECTION GUIDE

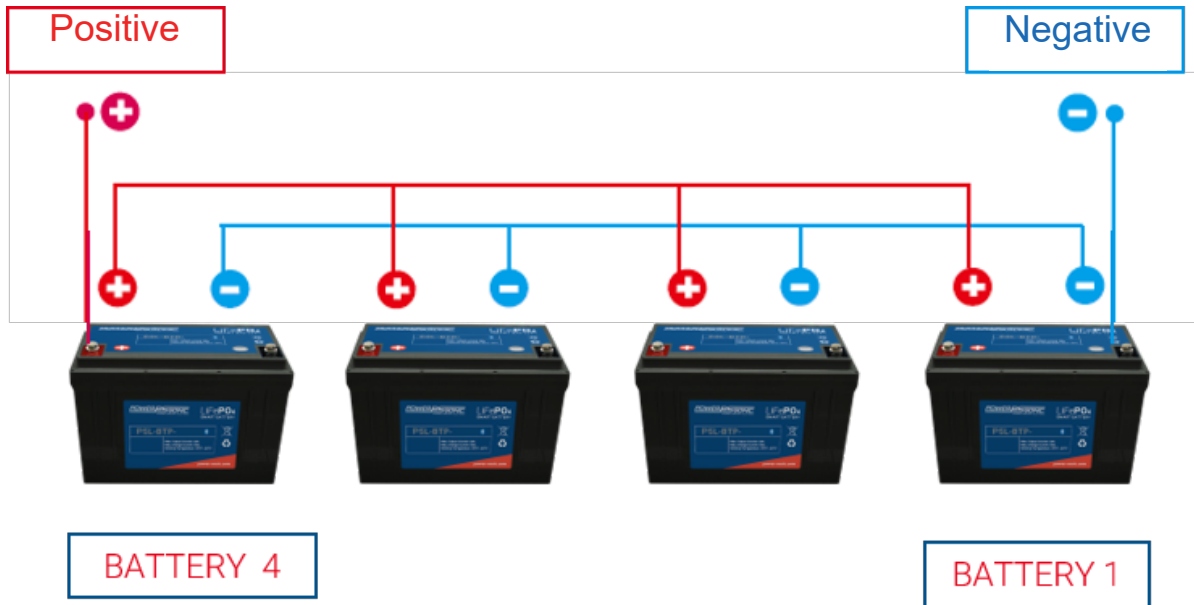

PARALLEL CONNECTION GUIDELINES

CAUTION:

Severe damage to the battery, short circuiting and sparking will happen if the batteries are not connected correctly or properly maintained. We recommend assembly be completed by fully trained professionals only.

Do not reverse connect the anode and cathode, as this will damage the batteries and/or any equipment connected.

DO NOT connect the batteries in parallel AND series at the same time.

Before install

Ensure wires can withstand twice the capacity rating of the battery. (Ex: PSL-BTP-121250 has a capacity of 125Ah, so the wire must be able to withstand 250A.)

Charge all batteries with 14.6V per standard charge.

Ensure all batteries have the same voltage level by fully charging each battery prior to connecting in parallel. (Voltage difference <0.2V)

Install

Make sure the connections are tight and the connector is protected from corrosion, wear, and seismic situations. Connecting impedance <0.1mΩ

DO NOT connect more than 4 batteries per circuit.

Maintenance

Make sure capacity stays within 50-60% when storing the batteries. The temperature should be 0-35° C, humidity 75-85% and fully charged every 3 months and discharged to 50-60% capacity.

Once a year, the batteries should be removed from string and individually charged. The voltage difference upon reassembly should be no more than 0.2V.

SERIES CONNECTION GUIDELINES

CAUTION:

The PSL-BT line cannot be used in series. For series connections, the PSL-SH and PSL-SC lines can be used.